

rejuvenate your brand!



Product Catalogue



Catalogue Content

Traditional Product Range

- [06](#) Bannerwalls
- [07](#) Gazebo's
- [08](#) Umbrellas
- [09](#) Fencewrap / Pennants
- [10](#) A-Frames
- [11](#) Tablecloths | Pennants
- [12/13](#) Display Banners
Telescopes | Harps | Custom | Windcheaters
- [14](#) X Frame Banners
- [15](#) Pull Up Banners
- [16](#) Desk | Waving | Car Flags
- [17](#) Corporate | Country Flags
- [18](#) Cluster Flags
- [19](#) Bannerpoles
- [20](#) Lightboxes
- [21](#) Fabric Frames

Luxurious Interiors

- [24](#) Wallpaper
- [25](#) Canvases
- [26](#) Window vinyl | One way vision
- [27](#) Custom Carpet | Floor vinyl

Re-Board

- [28/29](#) Introduction to Re-Board
- [30](#) Display Stands | Exhibition Stands
- [31](#) Point of Sale Display Systems
- [32](#) Custom Furniture
- [33](#) Forrex | Corex | ABS | Di-Bond | Perspex
- [34/35](#) Media Introduction

Key

							
24 hour service.	Delivery nationwide.	Easy to assemble.	Environmentally friendly.	Short lead times.	High res' print up to 1440dpi.	Recyclable materials.	Flame retardent materials.

*All brands and logos depicted in this brochure are used for the purpose of visual presentation only and remain the sole property of the relevant companies, organizations and institutions which to which they belong.



Carry Bag

Curved Bannerwall

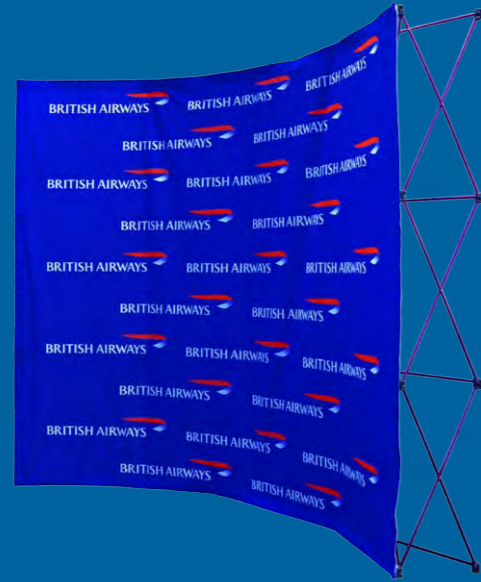

Standard Bannerwall

Bannerwalls

Traditional Product Range

- Bannerwall's are digitally printed onto Bannerweave **(as a single panel)**
- Versatile backwall exhibition stand
- Lightweight and easily assembled in less than three minutes by one person
- Various sizes available, supplied as a single unit in a carry bag

Sizes:	2.25 x 2.25m	2.25 x 3m	2.25 x 4.5m
Weights:	10.2kg	12.96kg	13.8kg



Gazebos

Product description

- Gazebos are digitally or screen printed onto water-resistant canvas in full or spot colour
- Frame and skin supplied as a single unit with carry bag & toolkit
- Quick and easy to set up
- Excellent product for outdoor, all day events
- Walls are available on request *(only on Standard Gazebos)*

Sizes:	2.5 x 2.5m	2.8 x 2.8m	2.8 x 4.2m
Weights:	17kg	19kg	31kg



Econo Gazebo
(with optional mini tarp banners)

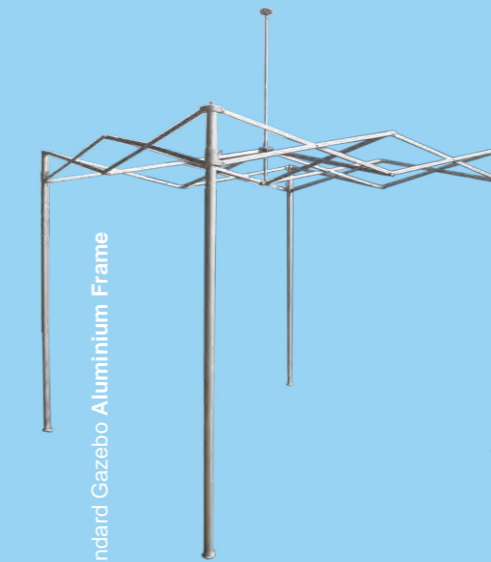

Standard Gazebo Aluminium Frame



Standard Gazebo
(with walls)



Carry Bag



Standard Gazebo



Umbrellas

Product Description

- Digitally or screen printed onto water resistant canvas
- Frame and skin supplied as a single unit in a carry bag, option of concrete or rubber base
- Quick and easy to set up
- Excellent product for outdoor, all day events

Sizes:	1.9m x 1.9m	2.5m x 2.5m
Weights:	6.2kg	7.3kg

Concrete base: 50kg **Rubber base:** 50kg



concrete base

rubber base

carry bag



Fencewrap

Product description

- Fencewrap is digitally or screen printed onto Ribtex
- Ribtex has small reinforced holes for better airflow
- Ideal for marathons, cycling or any outdoor events supplied in panels in required lengths
- May be supplied with support steel pegs - 1 or 2m

Sizes: Custom made to client's specifications

Ribtex has small reinforced holes and ribs for better airflow

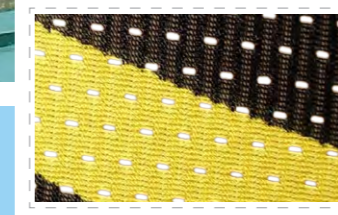

Pennants

Product description

- Pennants are digitally or screen printed onto PVC
- Single or double sided option available
- Suitable for indoor and outdoor use.
- Can be cut out in any shape required

Sizes: Standard size 20 x 30cm

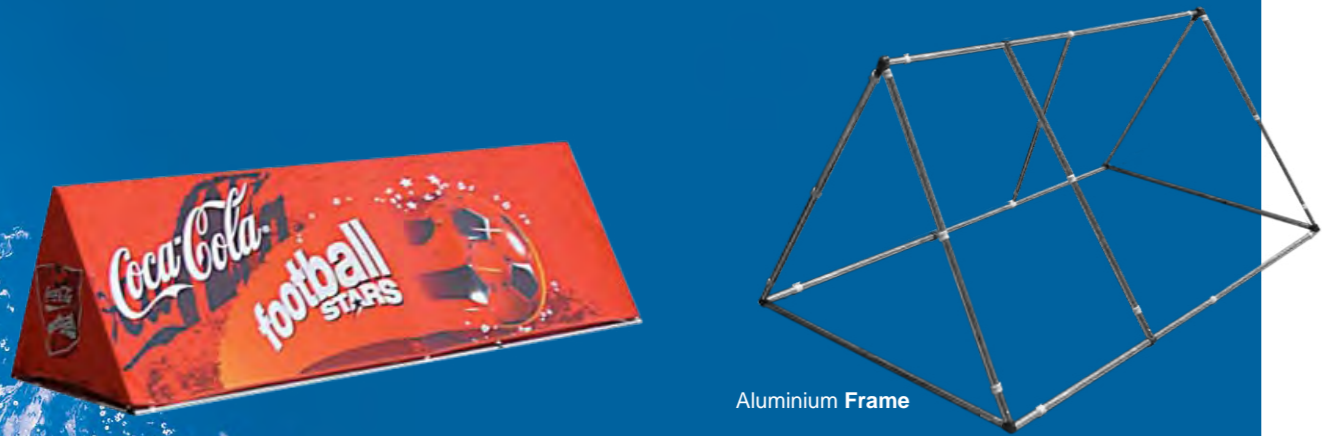

Aluminium Frame



Carry Bag

A-Frame Banners

Product Description

- Digitally or screen printed onto Bannerweave
- Supplied with or without side panels
- Lightweight aluminium frame + carry bag
- Ideal for tournaments, golf events or showrooms
- Easy to assemble, in under 3 minutes by 1 person

Sizes:	2m x 1m	3m x 1m
Weights:	3.1kg	4.6kg

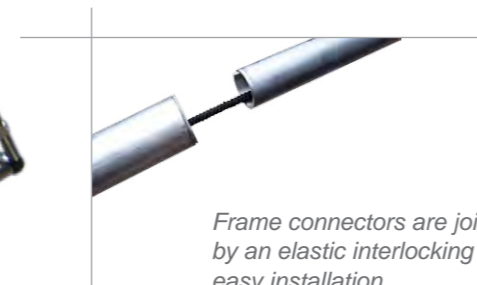

Frame connectors are joined by an elastic interlocking rope for easy installation.

Tablecloths

Product description

- Tablecloths are digitally or screen printed onto Bannerweave
- Ideal for press conferences, boardrooms, events etc.
- Made to fit any table shape round or square

Sizes: Custom made to client's specifications



Indoor / Outdoor Display Banners



Telescopic Banners



Harp Banners



Custom Banners



Windcheater Banners



Carry Bag



Display Banners

Product description

- Display banners can be digitally or screen printed onto Ultrasheen, single or double side
- Rods are either fibreglass or aluminium
- Standard outdoor spikes are bearing operated and electroplated
- Excellent product for outdoor and indoor use
- Various base options available

Sizes:	2m	3m	4m
Weights:	1.72kg	2.18kg	2.68kg
	2.6kg	3.18kg	3.68kg

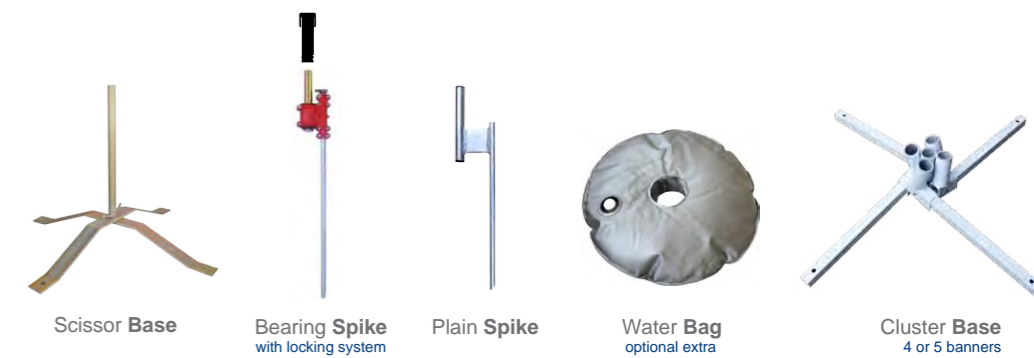

Scissor Base

Bearing Spike with locking system

Plain Spike

Water Bag optional extra

Cluster Base 4 or 5 banners

Econo Base

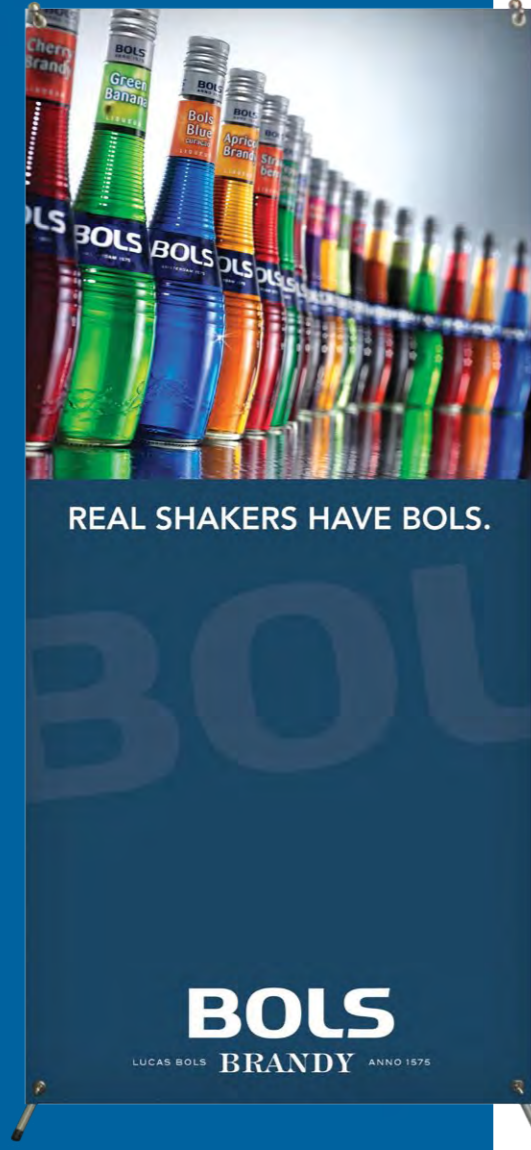

X-Frame Banners

Product Description

- Digitally or screen printed onto PVC
- Banner collapses to fit into a small bag
- Assembly takes less than one minute by a single person
- A favourite for showrooms and shopping mall displays
- PVC Banner is interchangeable

Sizes:	0.75m x 1.7m
Weights:	2.1kg



Pull Up Banners

Product description

- Pull-Up banners are digitally or screen printed onto PVC or fabric
- Banners stand 2m tall when open
- PVC banner retracts into base for portability
- May be single or double sided
- Supplied with carry bag

Sizes:	0.85m x 2m	1.2m x 2m
Weights:	2.1kg (econo)	6.68kg (standard)
	3.72kg (standard)	
	7.22kg (d/sided)	



Carry Bag

Cluster Desk Flag



Cross Desk Flag



Single Desk Flag



Desk | Waving | Car Flags

Product Description

- Flags are digitally or screen printed onto Ultrasheen / Pongee
- Supplied with plastic or wooden sticks / bases
- Car flags are supplied with either a window clip or a magnetic base

Size: Various sizes - made to clients specifications



Car Flag



Waving Flags



Car Mirror Socks



Corporate & Country Flags and Flagpoles

Product description

- Country flags are screen printed onto Bannerweave
- Corporate flags may be digitally or screen printed
- Supplied with rope and toggle, may also be supplied with aluminium flagpoles
- Ground, roof or wall mounted poles

Flags of the World

We stock most country flags in various sizes

Flags may be purchased with a countrywide **Service and Rental Plan.*

Flag Sizes: storm - 90 x 60cm, standard - 180 x 120cm, ceremonial 270 x 180cm, advertising flags 120 x 300cm custom sizes available on request

Flagpole Sizes: 6m, 9m, 12m & 15m (standard or swivel base)





Cluster Flags

Product Description

- Flags may be digitally or screen printed
- Cluster flags are available in sets of 4 or 5
- Hardware is aluminium and folds neatly into a small bag

Size: 6m Poles | 120 x 300cm Flags
Weight: 22kg



5 Pole Base

Carry Bag



Bannerpoles

Product description

- Our banners are digitally or screen printed onto opaque PVC - single or double sided
- Poles may be powdercoated to any colour to really shout out your corporate colours
- Bannerpoles are installed by our installation team
- Double or single banners options available
- May be roof or ground mounted

**Bannerpoles may be purchased with our countrywide Service and Rental Plan.*

Pole sizes: 3m, 5m and 8m
 Banner sizes: 75 x 225cm, 80 x 200cm, 100 x 400cm
 custom sizes available on request

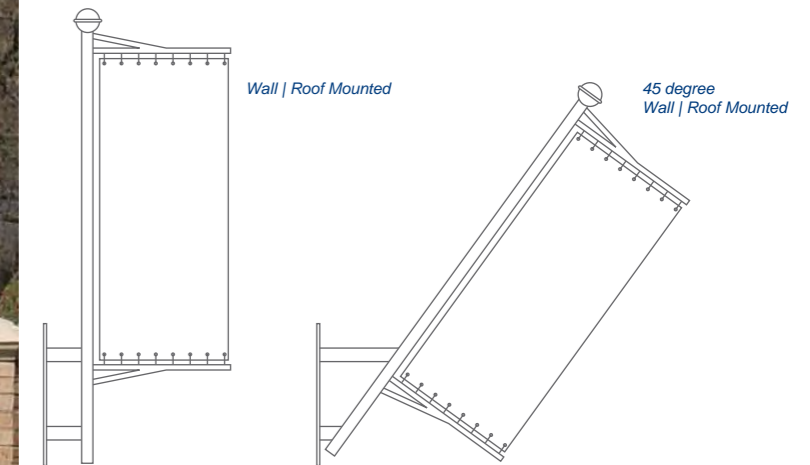



Ultrathin LED Lightbox



Fluorescent Lightbox

Lightboxes

Product Description

- Lightboxes are either printed on vinyl
- Light source may be LED or fluorescent lamps
- Hardware is aluminium and snaps to hold print
- Print is easily interchangeable

Sizes:	A4	A3	A2	A1
Weights:	1.3kg	2.2kg	3.1kg	5.5kg



Fabric Frames

Product description

- Our fabric frames are made up of a fabric print stretched over an aluminium frame
- Banner is digitally printed onto Bannerweave
- Frames are freestanding and may be tiled to make a giant display unit
- May be double or single sided
- Frames may be freestanding or wall mounted

Sizes: Standard size 1m x 2m
 Custom sizes made to client's specifications



canvas prints



branded cubes



LUXURIOUS INTERIORS

Luxurious Interiors

Interior Decor Product Range

Luxurious Interiors caters for the interior design / decor market. Our product range is specially targeted at interior spaces in the office or at home. We specialise in the conceptualisation, design and application of various interiors to suit any style, image or need.

Our state of the art printers are able to print on a large variety of materials and surfaces, which include:

- Perspex
- Canvas
- Glass
- Wallpaper
- Vinyl
- Forex
- Correx
- ABS
- Di-Bond





Custom Wallpaper

Product Description

Whether you are looking for corporate wallpaper that embodies your corporate image or personality, wallpaper for childrens rooms, personal living space or any custom interior wallpaper theme - *we can make it happen!*

Our wallpaper is:

Made to client specifications

Fully customisable ***may be applied to ceilings

Thousands of stock images to choose from:

Nature, abstract, buildings, seasons, people, places...



Canvas Fabric Prints

Product description

Define your space with these fully customizable professionally mounted canvas prints. Whether you are a business owner, designer, decorator or just passionate about your living and work space, these stylish canvases are an ideal way to improve the look and feel of your home or business. Perfect for restaurants, reception areas, doctor's rooms, office design, lounges, meeting rooms and your personal living space.

Canvas Prints are:

-made to clients specifications

-fully customizable

Thousands of stocked designs and images available:

Nature, decor, abstract, design, seasons, people, places



Wall mounted Fabric Frames



1 Way Vision | Window Vinyl

Product Description

One way vision vinyl is a unique product that brings life and colour to any transparent surface. It gives a sleek, modern and trendy look and feel to shop fronts, or any interior window-like surfaces.

Create spectacular advertisements, signs or decorative designs whilst allowing a clear view out and allowing light in.

Other vinyl types on offer include:

- Static vinyl
- Magnetic vinyl
- Conforming vinyl
- Sandblast vinyl
- Clear vinyl



Custom Carpet | Floor Vinyl

Product description

Floors are not dead space! Give your floor space that WOW factor. Custom printed carpets / vinyls are ideal for events, exhibitions, enhancing your corporate identity or rejuvenating your office or living space. The use of our digital technology enables us to print any design in crisp, brilliant colours and shades.

Carpets / vinyls are:

- Made to client specifications
- Fully Customizable

Thousands of stocked designs and images available:
Nature, decor, abstract, design, seasons, people, places



Branded Carpet - Closeup



Floor vinyl

introducing

Re-Board

Product description

Welcome to the world of Re-Board!

Re-board is a unique, patented, environmentally friendly paper based board product that is exceptionally strong lightweight and endlessly versatile. This highly successful international product may be printed, rapidly cut into any conceivable design and beautifully finished to produce sleek modern look.

As an **Officially Licenced Supplier** of the Re-board product range, we have access to thousands of unique Re-board product designs ranging from furniture, tables and one of a kind point of sale designs.

With Re-board the possibilities are infinite!



Re-board®

Super Strong - Super Light



Display counters

Display / serving counters are easily crafted from Re-Board into required shape / design to suit your requirements.



Exhibition Displays

If you can conceptualise it, we can make it. Go wild with your concepts and we will bring them to life.



Portal - Square Profile Pillars

A sturdy base design for portals - the shape of the top sign can easily be changed to fit your specific needs..



Custom Display POS Units

Space saving attractive POS display units, excellent for product launches or unique displays.



Point of Sale Display Systems

Product description

When it comes to promotions, brand activation, events or product marketing Re-board let's you expand your horizons with show stands that are guaranteed to make your product or brand stand out from the rest.

Due to its strength, maneuverability and versatility Re-board represents the future in display stand design. Customised units may be printed and cut to create highly functional, attractive and modern display stands. Any shape / design is achievable whether two or three dimensional.

Perfect for events, promotions or even for use in your showroom.





Re-Board - Custom Furniture

Product description

Made 100% from Re-board, this trendy furniture is lightweight and incredibly durable. Very stable and easy to assemble. The seat and backrest can be branded, which makes this the perfect product for campaigns with printed messages.

Beautifully finished and with crystal clear prints, this furniture is ideal for any interior setting, promotions or any branding requirements.

Print big, be colourful, get creative and get noticed!



Forex | Correx | ABS | Di-Bond | Perspex

Product description

Forex, Correx, ABS, Di-Bond and Perspex printed boards are often used for company building signs, information boards, hoardings, event signage or point of sale display units. Across these substrates you can print temporary to permanent signage depending on requirements.

As with our other printed boards they're printed using digital flatbed technology, with a near photographic quality print. Custom products may easily be printed and cut out in any shape for stunning 2D or 3D display units.



Forrex direct print with spot varnish coat

Di-Bond direct print

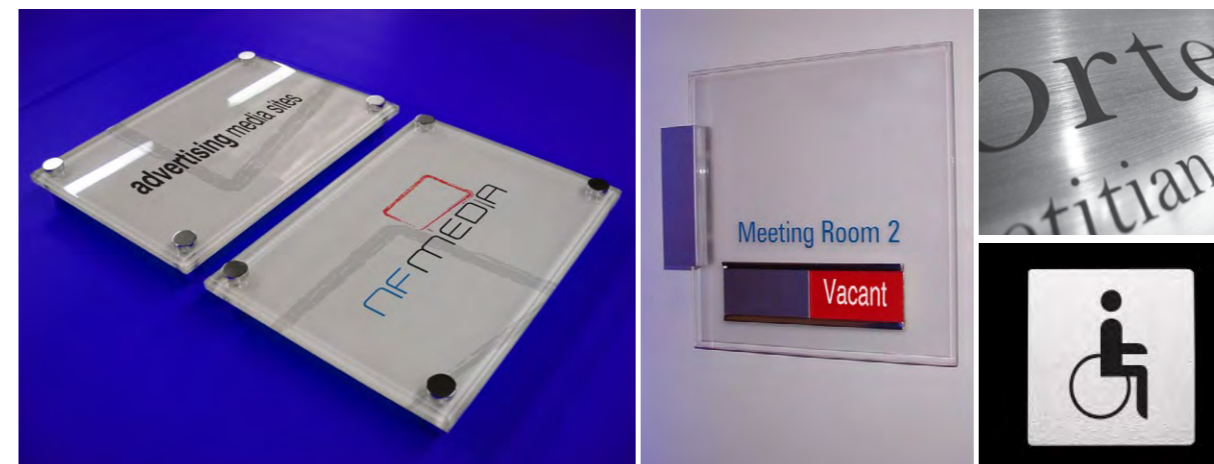

Perspex direct print with white white base print

Clear Perspex direct print

Di-Bond direct print

Rigid Substrates		Forex
		ABS
		Perspex
		Di-Bond
		Correx
		Re-Board 5mm
		Re-Board 10mm
		Re-Board 16mm



Outdoor Media Advertising

Advertising Media Sites

Unique media space advertising company with a focus on highly creative and attractive advertising spaces. With Access to some of the most sought after and exclusive sites in the country we guarantee optimum visibility for your brand.

Sites location:

OR Tambo International Airport

Building wraps | Trolleys | Chairs | Airbridges | Pillar Wraps | Indoor Billboards etc.

Cape Town International Airport

Building wraps | Trolleys | Chairs | Airbridges | Pillar Wraps | Indoor Billboards etc.

King Shaka International Airport

Building wraps | Trolleys | Chairs | Airbridges | Pillar Wraps | Indoor Billboards etc.

Melrose Arch

Hoarding (image on left) | Pillar Wraps | Indoor Billboards

Albertina Sisulu R24 Highway

Highway Bannerpoles

Johannesburg CBD

Building Wraps

